



## TRACKED EXCAVATOR | JS300 LC/NLC

Net engine power: 180 kW (241 hp) Bucket capacity: 0.86 – 1.93 m<sup>3</sup> Operating weight: 31 140 – 33 487 kg





# DURABILITY AND RELIABILITY.

BEFORE YOU BUY AN EXCAVATOR, YOU NEED TO KNOW IT'S GOING TO BE TOUGH ENOUGH TO PERFORM ANY JOB YOU ASK OF IT. FORTUNATELY, WITH A JCB JS300, STRENGTH AND DURABILITY COME AS STANDARD.



On the upper structure, there is a large storage space available to store chains and other essential accessories. We have added a new cover over the washer fluid bottle to maximise usable space.

## Boom and dipper.

1 A JCB JS300 reinforced boom and dipper is made of high tensile strength steel, with internal baffle plates for long life durability. In addition we fit heavy-duty wear strips at the dipper end for increased durability.

2 Our advanced manufacturing and assembly processes produce high precision and quality assembled components.

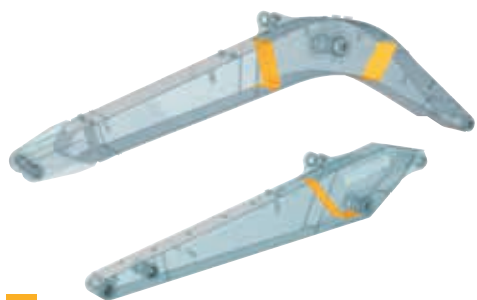

1

## Componentry.

3 JCB JS300 boast the best components in the industry, including Berco running gear, Kawasaki pumps and Kayaba main control valves.

The MTU 6-cylinder 180 kW engine uses a multi-stage fuel filtration system. This consists of a remote primary filter with built in water separator and secondary engine mounted filter. This system protects against a wide range of types of contaminants in fuel. A fuel shut off tap is fitted as standard along with a self priming lift pump for easy and simple servicing.



3



3

We use Finite Element Analysis with extensive rig and endurance testing to make key components last longer.



2

### Structural strength.

- 4 The high-strength undercarriage of a JCB JS300 uses a fully-welded X frame construction for long-term durability even in the most demanding applications.
- 5 A closed box section revolving frame increases strength and reduces stress. It is also highly resistant to impact damage.
- 6 The JS300's high-strength rigid upper frame provides maximum durability and support.
- 7 Our stiff, durable door design gives great strength and rigidity.

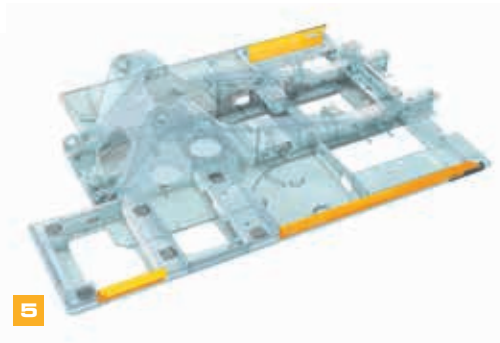



# MAXIMUM PRODUCTIVITY, MINIMUM SPEND.

IT'S MORE IMPORTANT THAN EVER TO SAVE MONEY AND TIME; THE JCB JS300 RANGE IS DESIGNED TO MAKE THE MOST OF BOTH.

## Upping output.

- 1 With up to a massive 247 kNm of bucket tearout and fast cycle times, the JS300 is extremely productive in all applications
- 2 Simultaneous tracking and excavating is smooth and fast with an intuitive multifunction operation.

## Efficiency.

Advanced hydraulic technology ensures that the machines always starts in idle for maximum fuel efficiency, contributing to fuel savings.

- 3 The MTU 6R1000 7.7-litre engine produces a formidable 180 kW of power and 1000 Nm of torque, and works in harmony with the SMART control electronics to deliver smooth high torque power even at low RPM.

An electric fan clutch automatically adjusts the fan speed based on the cooling demands. This reduces both noise and fuel consumption.



The JS300's have variable power bands that allow you to tailor performance – and therefore economy – to specific tasks.



To save fuel, JCB Auto-Idle technology automatically reduces engine speed when hydraulics aren't in use.

**Stability, hydraulics and attachments.**

4 JCB's innovative hydraulic regeneration system means oil is recycled across the cylinders for faster cycle times and reduced fuel consumption.

5 A JCB JS300 has cushioned boom and dipper ends to prevent shock loadings, protect your machine and increase operator comfort.

JCB SMART Control gives access to variable working modes. The manually selectable High Plus mode offers great efficiency, with 5% gains over outgoing models.

For ultra versatility, JCB offers a full list of auxiliary pipework options including hammer, auxiliary, merged and low flow.





## A COMFORTABLE FAVOURITE.

JCB EXCAVATORS ARE DESIGNED AROUND THE OPERATOR. THAT'S GOOD FOR THEM BUT EVEN BETTER FOR YOU; AFTER ALL, GREAT COMFORT AND EASE OF USE EQUALS GREAT PRODUCTIVITY.

### Visibly better.

**1** A 70/30 front screen split gives JCB JS300s excellent front visibility. A clear view of the front right track provides easy, safe trench digging and manoeuvring.

**2** An innovative low-level bonnet provides excellent rearward visibility.

### Comfortably in control.

**3** The 7" colour multi-function display is easy to read in all light conditions, provides instant operational information, and has a customisable home screen.

JCB's new basic tool select system (fitted as standard) allows the operator to set up the single direction auxiliary and hammer circuit to match flow the requirements. The selected flow is achieved by automatically adjusting the engine rpm when the hydraulic service is operated.

You can easily check your JS300's DEF usage and level via the in-cab LCD monitor, which also warns you if you're running low.



A large laminated glass roof window gives the JS300 optimum visibility for working at height.

Light, intuitive and smooth controls improve comfort and productivity. The JS300's joystick-mounted power boost button gives extra hydraulic power fast.

A balanced slew and electronic/hydraulic controlled slew braking give speed and precision.



## The working environment.

**4** The JS300 creates a quieter working environment inside and out. Therefore, you can use the machine at any location, any time.

Our cabs use 6 viscous rubber mounts to minimise noise and vibration.

**5** JCB's climate control has been fully revised and is now standard, and offers a precisely controlled cab temperature with fresh or recirculated air. Demisting/defrosting functions keep the front window clear.

**6** There's a spacious luggage tray behind the operator's seat.

A large floor area with large high grip pedals gives easy and precise tracking.

The Plus Pack is available as an option, and delivers a variety of enhancements to improve the operator experience.



The JS300's cab and controls are independently adjustable so that it's easy to find the perfect operating position.

We offer tailored seating options to suit many different applications.



# LESS SERVICING, MORE SERVICE.

WE'VE DESIGNED JCB JS300 TO BE LOW MAINTENANCE AND EASILY SERVICEABLE. WHICH MAKES THEM AFFORDABLE, EFFICIENT AND HIGHLY PRODUCTIVE. HELPING YOU GET THE BEST SERVICE FROM YOUR MACHINE.



Because worksites get dirty, we've equipped these excavators with a new and improved easy-to-clean-toolbox.

By using graphite impregnated bronze bushes, we've reduced the JS300's boom and dipper greasing intervals to 1000 hours for normal applications.

## Easy does it.

**1** The air filter on a JS300 is easily accessible, and a double-element construction simplifies cleaning. The latest JCB Powercore air filter is fitted as standard, so cleaning intervals are longer than ever.

**2** The filters on a JCB JS300 (engine oil, hydraulic oil and fuel) are centrally located for fast, easy servicing. By reducing the number of fuel filters from three to two, we've cut the amount of routine maintenance you need to do on your excavator.

Unlike many Tier 4 Final excavators, JCB JS300s don't require a diesel particulate filter (DPF). This eliminates the need for costly servicing or replacement of the filter. No filter also means no regeneration cycles, preventing any productivity constraints.

Filling your JS300 with DEF fluid is easily accessed via the upper structure. You can also access all main DEF components from there too.

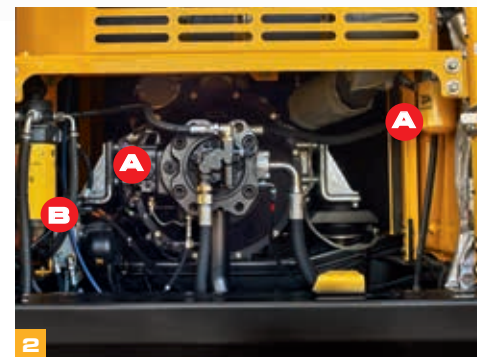

(A) Hydraulics oil filters (B) Fuel filters

	SERVICE INTERVALS
Engine oil and oil filter	Every <b>500</b> hours
Hydraulic oil	Every <b>5000</b> hours
Hydraulic oil filter	Every <b>1000</b> hours



### Here to help.

- 3 JCB's Smart Control automatically checks the engine oil and engine coolant level on machine start up.
- 4 Because they're mounted side by side on a JCB JS300, the engine radiator, hydraulic cooler and intercooler can be serviced individually yet cleaned easily.
- 5 Service your JCB JS300 with your local main dealer and our trained engineers can minimise downtime. Order genuine JCB parts online and, in 95% of cases, they'll be with you next day. For extra security and machine protection, opt for a package like JCB LiveLink remote machine monitoring.



JCB JS300 grease points are centralised for safe and easy access to high level pivots.

The JCB JS300 bonnet opens and closes easily with gas-assisted cylinders, and the service bays are large and wide for good access.



3



4



5



5

## THE SAFE CHOICE.

ON-SITE SAFETY IS CRUCIAL, SO WE'VE DESIGNED THE JS300 TO INCORPORATE AS MANY CUTTING EDGE SAFEGUARDS AS POSSIBLE. IN SHORT, YOUR OPERATORS ARE IN SAFE HANDS.



**1** The JCB JS300 bonnet opens front-to-rear for easy and safe engine service access. To make operator access safer, we've installed a tread plate over the engine.

A fuel shut-off tap provides a quick, safe way to change fuel filters and reduce the risk of spillage and contamination.

**2** For extra peace of mind, JCB JS300 cabs are available with an optional external ROPS and FOPS protection.



**3** JCB's Safety Lever Lock fully isolates hydraulic functions to avoid unintended movements. Our 2GO system means a JCB JS300 can only be started in a safe locked position via two separate inputs.

**4** JCB JS300s have a large glass area and low bonnet line for superb visibility.

**5** A JCB JS300's steps and platforms have anti-slip punched steel plates for optimum grip, even in wet or icy conditions. Bolt-on plates have recessed bolts to reduce trip hazard. We've also reconfigured the step arrangement so there's now a handy extra toolbox for secure storage.



We've fitted as standard a bulk head heat shield between the pumps and the engine to guard against heat and noise.





**6** A standard rear view camera displays uninterrupted rearward views on the smart controller display.

**7** Our JS300 comes equipped with a full set of side and rear view mirrors as standard, providing all round visibility and safety compliance.

To reduce the risk of costly mistakes, we've made DEF and diesel tanks very distinct on the new JS300. They're coloured and named differently, opened by different keys, and have different-sized nozzles so you can't accidentally put diesel in the DEF tank.

Our factory-fit immobilisers can reduce your insurance premiums. Featuring automatic arming after a set time following engine shutdown.

JCB LiveLink telematics technology provides you with essential reports on everything from vehicle usage to fuel economy, idle time and engine load data.



5



6



6



7



7

# LIVELINK, WORK SMARTER.

**LIVELINK IS AN INNOVATIVE SOFTWARE SYSTEM THAT LETS YOU MANAGE JCB MACHINES REMOTELY – ONLINE, BY EMAIL OR BY MOBILE PHONE. ACCESS EVERYTHING FROM MACHINE ALERTS TO FUEL REPORTS AND HISTORY INFORMATION, WITH ALL DATA STORED AT A SECURE CENTRE.**

## Productivity and cost benefits

By providing information like idle time monitoring and machine fuel consumption, JCB Livelink helps reduce your fuel usage, saving money and improving productivity. Machine location information can help improve efficiency and perhaps even reduce insurance costs.

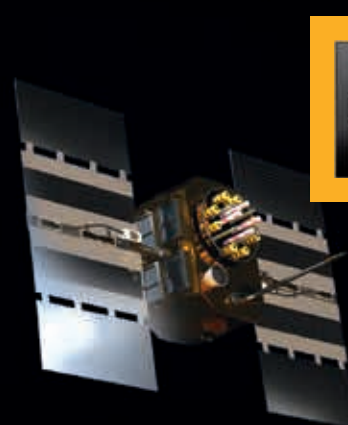

## Maintenance benefits

Manage machine maintenance easily – accurate hours monitoring and service alerts improve maintenance planning, while real-time location data helps you manage your fleet. Critical machine alerts and maintenance history records are also available.



## Security benefits

Livelink's real-time geofencing alerts tell you when machines move out of predetermined zones, and real-time curfew alerts inform you of unauthorised usage. Further benefits include real-time location information, advanced ECU matching (pairs Livelink with the immobiliser or ECU).





## VALUE ADDED.

JCB'S WORLDWIDE CUSTOMER SUPPORT IS FIRST CLASS. WHATEVER YOU NEED AND WHEREVER YOU ARE, WE'LL BE AVAILABLE QUICKLY AND EFFICIENTLY TO HELP MAKE SURE YOUR MACHINERY IS PERFORMING TO ITS FULL POTENTIAL.



1

1 Our Technical Support Service provides instant access to factory expertise, day or night, while our Finance and Insurance teams are always on hand to provide fast, flexible, competitive quotes.

2 The global network of JCB Parts Centres is another model of efficiency; with 16 regional bases, we can deliver around 95% of all parts anywhere in the world within 24 hours. Our genuine JCB parts are designed to work in perfect harmony with your machine for optimum performance and productivity.

Note: JCB LIVELINK and JCB ASSETCARE may not be available in your region, so please check with your local dealer.



2

3 JCB Assetcare offers comprehensive extended warranties and service agreements, as well as service-only or repair and maintenance contracts. Irrespective of what you opt for, our maintenance teams around the world charge competitive labour rates, and offer non-obligation quotations as well as fast, efficient insurance repair work.



3

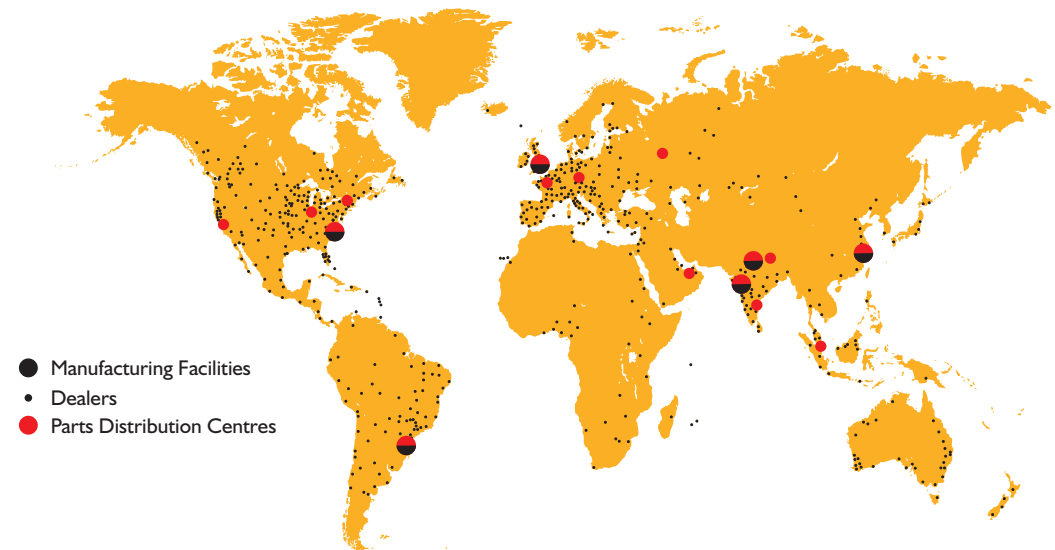

## STATIC DIMENSIONS

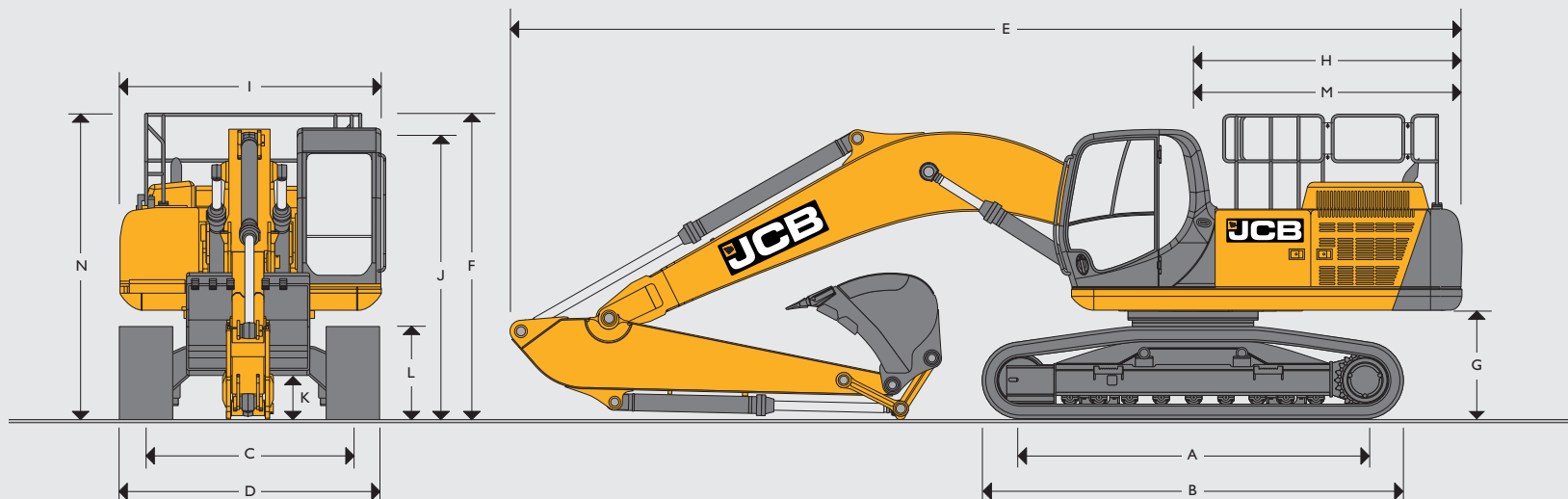

## STATIC DIMENSIONS

Model		LC	NLC	
A	Track length on ground	mm	3990	3990
B	Undercarriage overall length	mm	4843	4843
C	Track gauge	mm	2600	2390
D	Width over tracks (600mm trackshoes)	mm	3200	2990
D	Width over tracks (700mm trackshoes)	mm	3300	3090
D	Width over tracks (800mm trackshoes)	mm	3400	3190
D	Width over tracks (900mm trackshoes)	mm	3500	3290
G	Counterweight clearance	mm	1198	1198
H	Tail swing radius	mm	3251	3251
I	Overall width of superstructure	mm	2990	2990
J	Height over cab	mm	3181	3181
K	Ground clearance	mm	550	550
L	Track height	mm	1011	1011
M	Tail length	mm	3185	3185
N	Height over grab rail	mm	3344	3344

		Monoboom 6.2m			
Dipper lengths		2.5m	3.1m	3.7m	
E	Transport length	mm	10758	10630	10653
F	Transport height	mm	3375	3344	3344



ENGINE	
Model	MTU 6R1000 Tier 4 Final compliant
Type	Water cooled, 4-stroke, 6-cylinder in-line, common rail direct injection, turbocharged intercooled diesel.
Rated power (net)	180 kW (241 hp) at 1800rpm.
Piston displacement	7.7 litres.
Air filtration	Dry element with secondary safety element and in-cab warning indicator.
Starting system	24 volt.
Batteries	2 x 12 volt.
Alternator	24 volt, 100 ampere.

SLEW SYSTEM	
Slew motor	Axial piston type.
Slew brake	Hydraulic braking plus automatic spring applied disc type parking brake.
Slew torque	100.3 kNm
Slew speed	9.4rpm
Slew gear	Large diameter, internally toothed fully sealed grease bath lubricated.

UNDERCARRIAGE	
Carriage options	LC - Long Carriage and NLC - Narrow Long Carriage.
Construction	Fully welded, 'X' frame type with central bellyguarding and sloping sidemembers with dirt relief holes under top rollers.
Recovery point	Front and rear.
Track shoe options	600mm, 700mm, 800mm, 900mm.
Upper and lower rollers	Heat treated, sealed and lubricated.
Track adjustment	Grease cylinder type.
Track idler	Sealed and lubricated, with spring cushioned recoil.
Track type	Sealed and lubricated.
No. of track guides	2 per side
No. of lower rollers (each side)	9 per side
No. of upper rollers (each side)	2 per side
No. of track shoes	50 per side

TRACK DRIVE	
Type	Fully hydrostatic, two speed with autoshift.
Travel motors	Variable swash axial piston type, fully guarded within undercarriage frame.
Final drive	Planetary reduction, bolt-on sprockets.
Service brake	Hydraulic counter balance valve to prevent overspeeding on gradients.
Park brake	Disc type, spring applied, automatic hydraulic release.
Gradeability	70% (35 deg) continuous.
Travel speed	High – 4.6 km/h Low – 2.7 km/h
Tractive effort	221 kNm

SERVICE CAPACITIES		
Fuel tank	Litres	590
Engine coolant	Litres	39
Engine oil	Litres	25
Swing reduction gear	Litres	16
Track reduction gear (each side)	Litres	5
Hydraulic system	Litres	430
Hydraulic tank	Litres	239
DEF fluid capacity	Litres	47

HYDRAULIC SYSTEM	
A variable flow negative control system with flow on demand, variable power output and servo operated, multi function open centre.	

Pumps	
Main pumps	2 variable displacement axial piston type.
Maximum flow	2 x 250 l/min
Servo pump	Gear type.
Maximum flow	18l/min

Control valve	
A combined four and five spool control valve with auxiliary service spool as standard.	

Relief valve settings	
Boom/Arm/Bucket	343 bar
With power boost	372 bar
Swing circuit	290 bar
Travel circuit	343 bar
Pilot control	39 bar

Filtration	
In tank	150 micron, suction strainer.
Main return line	10 micron, glass fibre element.
Pilot line	10 micron, paper element.
Hydraulic hammer return	10 micron, reinforced microform element.

**BUCKET AND ARM COMBINATION**

Bucket options		GP Bucket				HD Bucket				Grade Bucket	
		950	1400	1550	1800	950	1400	1550	1800	2200	2500
Bucket width	mm	950	1400	1550	1800	950	1400	1550	1800	2200	2500
Bucket capacity	m <sup>3</sup>	0.86	1.43	1.62	1.93	0.86	1.43	1.62	1.93	1.71	1.96
Bucket weight	kg	834	1058	1145	1277	925	1189	1268	1428	1132	1256
<b>LC</b>											
2.5m	m	☐	☐	☐	☐	☐	☐	☐	☐	☐	☐
3.1m	m	☐	☐	☐	■	☐	☐	☐	■	☐	■
3.7m	m	☐	☐	■	●	☐	☐	■	●	■	●
<b>NLC</b>											
2.5m	m	☐	☐	☐	■	☐	☐	☐	■	☐	■
3.1m	m	☐	☐	■	■	☐	☐	■	●	■	●
3.7m	m	☐	■	■	●	☐	■	●	●	●	●

☐ = Suitable for general excavating (materials up to 2000kg/m<sup>3</sup>) ■ = Suitable for light excavating (materials up to 1600kg/m<sup>3</sup>)

● = Suitable for grading & loading (materials up to 1200kg/m<sup>3</sup>) \* Bucket capacity recommendations with no quick hitch fitted

**WEIGHTS AND GROUND BEARING PRESSURES**

Machine specified with a 3.1m dipper, 1.43m<sup>3</sup> Bucket, operator, full fuel tank, and standard counterweight.

		600mm shoes	700mm shoes	800mm shoes	900mm shoes
<b>LC</b>					
Machine weight	kg	31140	31490	32278	32687
Ground bearing pressure	kg/cm <sup>2</sup>	0.61	0.52	0.47	0.42
<b>NLC</b>					
Machine weight	kg	31013	31363	32151	32560
Ground bearing pressure	kg/cm <sup>2</sup>	0.61	0.52	0.47	0.42

**WORKING RANGE MONOBOOM 6.2M**

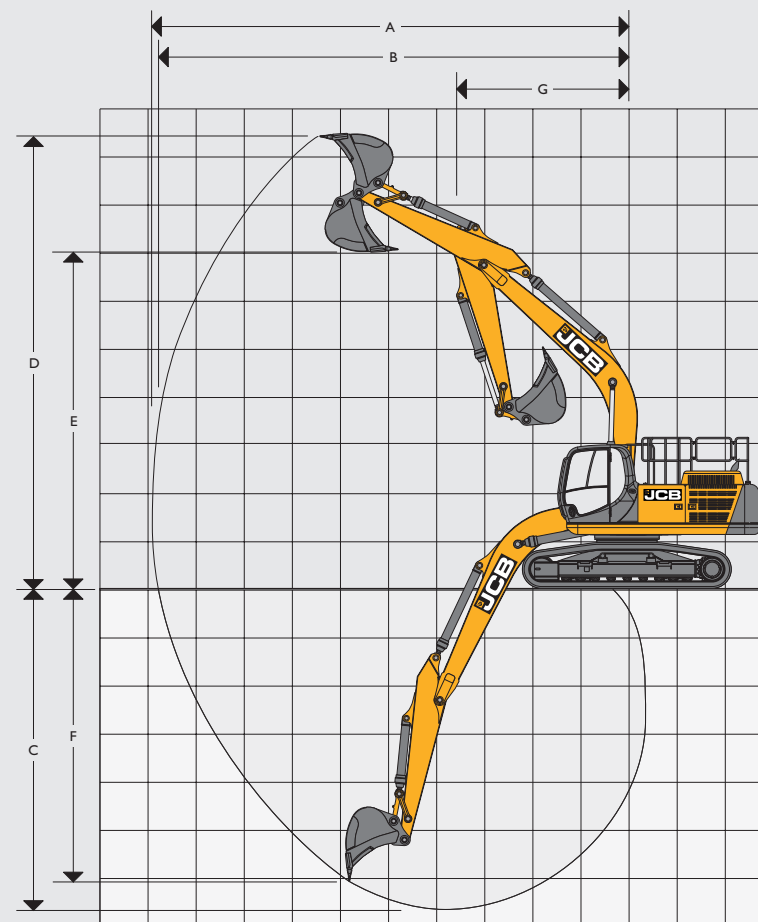

**WORKING RANGE MONOBOOM 6.2M**

Dipper length		2.5m	3.1m	3.7m	
A	Maximum digging reach	mm	10091	10655	11291
B	Maximum digging reach (on ground)	mm	9871	10447	11096
C	Maximum digging depth	mm	6477	7062	7637
D	Maximum digging height	mm	9769	10130	10719
E	Maximum loadover height	mm	6980	7298	7815
F	Maximum vertical wall cut depth	mm	3397	4229	5297
G	Minimum swing radius	mm	4183	4137	4046
	Bucket rotation	deg	185°	185°	185°
	Maximum dipper tearout	kNm	171.6	138.8	119.9
	Maximum bucket tearout	kNm	247.3	247.3	247.3



**STANDARD/OPTIONAL EQUIPMENT**

<b>ENGINE</b>	
MTU, Stage IV compliant, SCR, EGR, DOC, water-cooled diesel engine with Fixed Turbo Charger and air-to-air intercooler	•
Start pre-heat	•
DEF Tank	•
One touch idle	•
Auto-idle function	•
No DPF	•
Refuelling pump	•
Fan guard	•
Heavy duty batteries	•
Fuel filter with water seperator	•
Fuel shutoff tap	•
Electronic engine control	•
Fuel Cooler	•
Scavenge air filter	+
<b>SAFETY</b>	
Side guard rails on upper structure and steps	•
Rear-view camera	•
Battery isolator	•
Key	•
2 GO	•
Lockable fuel cap	•
Work lights (1 main frame, 2 boom mounted, 1 counterweight)	•
Additional work lights (2 cab mounted)	+
LED worklight upgrade	+
FOPS II guards – top and front	+
Demolition cage (FOPS level II)	XD only
Travel alarm	+
White noise travel alarm	+
Green beacon linked seat belt	+
Fire extinguiser	+
Vandal guards	+
Chevron counterweight	+
Roll Over Protective Structure (ROPS)	+
Boom and arm cylinder safety valves & overload warning	+
Rear counterweight safety handrails	+
Rotating beacon	+
2 x counterweight beacons	+















<b>CAB &amp; INTERIOR</b>	
Sound-insulated and 6 shock mounted cab	•
Mechanical suspension seat	•
Air conditioning with climate control	•
Opening front window and removable lower front window	•
Sliding left window	•
Upper windscreen wiper	•
3 button joysticks	•
Travel pedals and T hand levers	•
Immobiliser	•
Loudspeakers and connections for radio	•
Standard cab filtration	•
Electric horn	•
Interior cab light	•
12V power socket	•
7" colour monitor	•
Retractable 2" seat belt	•
3" seat belt	+
Full length front blind	+
Half length front blind	+
Heated, adjustable air suspension seat with adjustable headrest and armrest	+
Lower windscreen wiper	+
Radio	+
Carbon air filter	+
Deluxe seat: Heated, adjustable air suspension seat with adjustable headrest and armrest. Seat ventilation and electrical lumbar support.	+
Rain visor	+
<b>UNDERCARRIAGE</b>	
600, 700, 800, 900 mm triple grouser shoe	+
Narrow undercarriage	+
Greased and sealed track links	•
Twin track guards	•
<b>DIG END</b>	
No lift tipping link	•
Dippers: 2500 mm, 3100 mm or 3700 mm	+
XD Dipper: 2500 mm, 3100 mm or 3700 mm	XD only
Lifting hook t/link	+
Lifting shackle t/link	+
Bucket ram guards	+

<b>HYDRAULIC SYSTEM</b>	
Boom and arm flow regeneration	•
One-touch power boost function	•
Boom/slew priority control	•
Cushion control	•
Cylinder cushioning and contamination seals	•
Oil cooler	•
Control of auxiliary hydraulic flow and pressure from display panel with 10 tool setting storage	+
High and low flow aux options	+
Bio oil	+
Panolin oil	+
Quick hitch pipework	+
Hydraulic hitch	+
ISO/SAE changeover	+
Quick release couplings	+
Hose burst check valves	+
Breaker piping	+
Shut off taps	+















<b>OTHER</b>	
Liveline telematics	•
10mm Heavy-duty upper and lower belly plates	+
Side impact protection	+
Fly screens	+
Tracked tool kit	+
Guards for work lights	+
Heavy counterweight (5300kg)	+

**STANDARD** •  
**OPTIONAL** +















**LIFT CAPACITIES – Dipper length: 2.5m, Boom: 6.2m, Trackshoes: 600mm. JS300 LC MONO**

Load Point	Reach from Swing Centre														
	1.5m		3m		4.5m		6m		7.5m		9m		Max Reach		
															
Height	kg	kg	kg	kg	kg	kg	kg	kg	kg	kg	kg	kg	kg	kg	mm
7.5m							7700*	7700*					7810*	7090	6535
6m							8070*	78070*	7770*	5520			7780*	7810*	7565
4.5m					11580*	11580*	9180*	7660	8120*	5370			7330	4620	8190
3m					14730*	10770	10590*	7150	8240	5140			6750	4210	8501
1.5m							1230	6730	7990	4910			6580	4060	8533
0m					17610*	9820	10960	6490	7830	4770			4150	4240	8146
- 1.5m			13200*	13200*	16620*	9830	10880	6430	7800	4740			7450	4550	7748
- 3m			20440*	20440*	15140*	10020	11010	6540					9080	5500	6830
- 4.5m					11970*	10460							9890	8140	5338

**LIFT CAPACITIES – Dipper length: 3.1m, Boom: 6.2m, Trackshoes: 600mm. JS300 LC MONO**

Load Point	Reach from Swing Centre														
	1.5m		3m		4.5m		6m		7.5m		9m		Max Reach		
															
Height	kg	kg	kg	kg	kg	kg	kg	kg	kg	kg	kg	kg	kg	kg	mm
7.5m															
6m							7230*	7230*	7010*	5640				5190*	4770
4.5m					10220*	10220*	8390*	7820	7510*	5450				5230*	4130
3m					13410*	11160	9890*	7290	8270*	5180	6100*	3840	5460*	3790	9077
1.5m					15920*	10240	11280*	6810	8010	4930	6050	3720	5900*	3650	9108
0m					16990*	9820	10970	6490	7800	4740			6080	3710	8882
- 1.5m			12280*	12280*	16930*	9730	10820	6360	7710	4650			6580	4000	8378
- 3m	14130*	14130*	19190*	19190*	15890*	9840	10860	6400	7780	4720			7730	4690	7540
- 4.5m			18680*	18680*	13530*	10170	9900*	6650					9350*	6330	6227

**LIFT CAPACITIES – Dipper length: 3.7m, Boom: 6.2m, Trackshoes: 600mm. JS300 LC MONO**



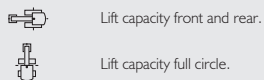











Load Point	Reach from Swing Centre														
	1.5m		3m		4.5m		6m		7.5m		9m		Max Reach		
															
Height	kg	kg	kg	kg	kg	kg	kg	kg	kg	kg	kg	kg	kg	kg	mm
7.5m										5780*	5300			3960*	3960
6m										6270*	5230			3800*	3710
4.5m							7520*	7250	6860*	5010	5860*	3600	3780*	3250	9469
3m					11970*	10340	9080*	6690	7690*	4720	6160	3460	3890*	2980	9738
1.5m					14850*	9270	10610*	6160	7980	4420	5990	3310	4140*	2870	9766
0m			6720*	6720*	16470*	8680	10900	5770	7720	4190	5860	3180	4550*	2900	9556
- 1.5m	7090*	7090*	10710*	10710*	16890*	8460	10660	5570	7570	4060	5800	3140	5250*	3090	9091
- 3m	11350*	11350*	15890*	15890*	16310*	8490	10630	5540	7560	4050			6480*	3540	8327
- 4.5m	16540*	16540*	20780*	17380	14570*	8720	10810	5690					8300	4500	7165

















- Notes:**
- Lifting capacities are based on ISO 10567, that is: 75% of minimum tipping load or 87% of hydraulic lift capacity, whichever is the less. Lifting capacities marked\* are based on hydraulic capacity.
  - Lift capacities assume that the machine is on firm, level ground.
  - Lift capacities may be limited by local regulations. Please refer to your dealer.

















**LIFT CAPACITIES – Dipper length: 2.5m, Boom: 6.2m, Trackshoes: 700mm. JS300 LC MONO**

Load Point	Reach from Swing Centre														
	1.5m		3m		4.5m		6m		7.5m		9m		Max Reach		
															
Height	kg	kg	kg	kg	kg	kg	kg	kg	kg	kg	kg	kg	kg	kg	mm
7.5m							7700*	7700*					7810*	7170	6535
6m							8070*	8070*	7770*	5580			7780*	5490	7565
4.5m					11580*	11580*	9180*	7740	8120*	5430			7410	4670	8190
3m					14730*	10890	10590*	7230	8340	5200			6830	4260	8501
1.5m							11370	6810	8090	4970			6660	4110	8533
0m					17160*	9940	11090	6570	7930	4830			6860	4200	8291
- 1.5m			13200*	13200*	16620*	9950	11020	6500	7900	4800			7550	4600	7748
- 3m			20440*	20440*	15140*	10140	11140	6620					9190	5570	6830
- 4.5m					11970*	15080							9890*	8230	5338

**LIFT CAPACITIES – Dipper length: 3.1m, Boom: 6.2m, Trackshoes: 700mm. JS300 LC MONO**

Load Point	Reach from Swing Centre														
	1.5m		3m		4.5m		6m		7.5m		9m		Max Reach		
															
Height	kg	kg	kg	kg	kg	kg	kg	kg	kg	kg	kg	kg	kg	kg	mm
7.5m															
6m							7230*	7230*	7010*	5700			5190*	4820	8210
4.5m					10220*	10220*	8390*	7900	7510*	5510			5230*	4180	8757
3m					13410*	11280	9890*	7370	8270*	5240	6100*	3890	5460*	3830	9077
1.5m					15920*	10360	11280*	6890	8110	4990	6130	3770	5900*	3700	9108
0m					16990*	9940	11100	6570	7900	4800			6150	3760	8882
- 1.5m			12280*	12280*	16930*	9850	10950	6440	7810	4710			6670	4060	8378
- 3m	14130*	14130*	19190*	19190*	15890*	9960	10990	6480	7880	4780			7820	4750	7540
- 4.5m			18680*	18680*	13530*	10280	9900*	6730					9350*	6410	6227





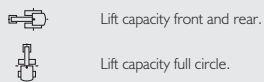









**LIFT CAPACITIES – Dipper length: 3.7m, Boom: 6.2m, Trackshoes: 700mm. JS300 LC MONO**

Load Point	Reach from Swing Centre														
	1.5m		3m		4.5m		6m		7.5m		9m		Max Reach		
															
Height	kg	kg	kg	kg	kg	kg	kg	kg	kg	kg	kg	kg	kg	kg	mm
7.5m									5780*	5780*			3960*	3960*	8089
6m									6270*	5790			3800*	3800*	8937
4.5m							7520*	7520*	6860*	5570	5860*	4030	3780*	3650	9469
3m					11970*	11630	9080*	7480	7690*	5270	6270	3890	3890*	3370	9738
1.5m					14850*	10530	10610*	6930	8110	4980	6100	3740	4140*	3260	9766
0m			6720*	6720*	16470*	9910	11080	6540	7580	4740	5960	3610	4550*	3300	9556
- 1.5m	7090*	7090*	10710*	10710*	16890*	9690	10850	6330	7700	4610	5910	3560	5250*	3510	9091
- 3m	11350*	11350*	15890*	15890*	16310*	9720	10810	6300	7700	4600			6480*	4010	8327
- 4.5m	16540*	16540*	20780*	20340	14570*	9960	10810*	6460					8410*	5090	7165

















- Notes:**
- Lifting capacities are based on ISO 10567, that is: 75% of minimum tipping load or 87% of hydraulic lift capacity, whichever is the less. Lifting capacities marked\* are based on hydraulic capacity.
  - Lift capacities assume that the machine is on firm, level ground.
  - Lift capacities may be limited by local regulations. Please refer to your dealer.















**LIFT CAPACITIES – Dipper length: 2.5m, Boom: 6.2m, Tracks: 800mm. JS300 LC MONO**

Load Point	Reach from Swing Centre														
	1.5m		3m		4.5m		6m		7.5m		9m		Max Reach		
															
Height	kg	kg	kg	kg	kg	kg	kg	kg	kg	kg	kg	kg	kg	kg	mm
7.5m							7700*	7700*					7810*	7330	6535
6m							8070*	8070*	7770*	5720			7780*	5630	7565
4.5m					11580*	11580*	9180*	7920	8120*	5570			7610*	4800	8190
3m					14730*	11160	10590*	7410	8560	5330			7020	4380	8501
1.5m							11670	6990	8310	5110			6840	4230	8533
0m					17160*	10200	11390	6750	8150	4960			7050	4320	8291
- 1.5m			13200*	13200*	16620*	10220	11320	6680	8120	4930			7760	4730	7748
- 3m			20440*	20440*	15140*	10410	11430*	6800					9440	5720	6830
- 4.5m					11970*	10850							9890*	8440	5338

**LIFT CAPACITIES – Dipper length: 3.1m, Boom: 6.2m, Tracks: 800mm. JS300 LC MONO**

Load Point	Reach from Swing Centre														
	1.5m		3m		4.5m		6m		7.5m		9m		Max Reach		
															
Height	kg	kg	kg	kg	kg	kg	kg	kg	kg	kg	kg	kg	kg	kg	mm
7.5m															
6m							7230*	7230*	7010*	5840				5190*	4940
4.5m					10220*	10220*	8390*	8080	7510*	5640				5230*	4290
3m					13410*	11550	9890*	7550	8270*	5380	6100*	4000		5460*	3940
1.5m					15920*	10630	11280*	7070	8330	5120	6300	3880		5900*	3810
0m					16990*	10210	11410	6750	8120	4930				6330	3870
- 1.5m			12280*	12280*	16930*	10120	11250	6620	8030	4850				6860	4180
- 3m	14130*	14130*	19190*	19190*	15890*	10230	11290	6660	8100	4910				8040	4880
- 4.5m			18680*	18680*	13530*	10550	9900*	6910						9350*	6580

**LIFT CAPACITIES – Dipper length: 3.7m, Boom: 6.2m, Tracks: 800mm. JS300 LC MONO**



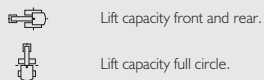











Load Point	Reach from Swing Centre														
	1.5m		3m		4.5m		6m		7.5m		9m		Max Reach		
															
Height	kg	kg	kg	kg	kg	kg	kg	kg	kg	kg	kg	kg	kg	kg	mm
7.5m									5780*	5780*				3960*	3960*
6m									6270*	5930				3800*	3800*
4.5m							7520*	7520*	6860*	5710	5860*	4140		3780*	3750
3m					11970*	11890	9080*	7660	7690*	5410	6440	4000		3890*	3470
1.5m					14850*	10790	10610*	7110	8330	5110	6270	3840		4140*	3360
0m			6720*	6720*	16470*	10180	11380	6720	8070	4880	6130	3720		4550*	3400
- 1.5m	7090*	7090*	10710*	10710*	16890*	9960	11150	6510	7920	4740	6080	3670		5250*	3620
- 3m	11350*	11350*	15890*	15890*	16310*	9980	11110	6480	7920	4740				6480*	4130
- 4.5m	16540*	16540*	20780*	20780*	14570*	10220	10810*	6640						8410*	5230

















- Notes:**
- Lifting capacities are based on ISO 10567, that is: 75% of minimum tipping load or 87% of hydraulic lift capacity, whichever is the less. Lifting capacities marked\* are based on hydraulic capacity.
  - Lift capacities assume that the machine is on firm, level ground.
  - Lift capacities may be limited by local regulations. Please refer to your dealer.

















**LIFT CAPACITIES – Dipper length: 2.5m, Boom: 6.2m, Tracks: 900mm. JS300 LC MONO**

Load Point	Reach from Swing Centre														
	1.5m		3m		4.5m		6m		7.5m		9m		Max Reach		
															
Height	kg	kg	kg	kg	kg	kg	kg	kg	kg	kg	kg	kg	kg	kg	mm
7.5m							7700*	7700*					7810*	7410	6535
6m							8070*	8070*	7770*	5790			7780*	5700	7565
4.5m					11580*	11580*	9180*	8010	8120*	5640			7710	4860	8190
3m					14730*	11300	10590*	7510	8670	5400			7110	4440	8501
1.5m							11800*	7080	8420	5180			6940	4290	8533
0m					17160*	10340	11550	6840	8260	5030			7150	4390	8291
- 1.5m			13200*	13200*	16620*	10360	11470	6780	8230	5010			7870	4800	7748
- 3m			20440*	20440*	15140*	10550	11430*	6890					9570	5800	6830
- 4.5m					11970*	10980							9890*	8550	5338

**LIFT CAPACITIES – Dipper length: 3.1m, Boom: 6.2m, Tracks: 900mm. JS300 LC MONO**

Load Point	Reach from Swing Centre														
	1.5m		3m		4.5m		6m		7.5m		9m		Max Reach		
															
Height	kg	kg	kg	kg	kg	kg	kg	kg	kg	kg	kg	kg	kg	kg	mm
7.5m															
6m							7230*	7230*	7010*	5910			5190*	5010	8210
4.5m					10220*	10220*	8390*	8170	7510*	5720			5230*	4350	8787
3m					13410*	11690	9890*	7640	8270*	5450	6100*	4060	5460*	4000	9077
1.5m					15920*	10760	11280*	7160	8450	5190	6390	3940	5900*	3860	9108
0m					16990*	10350	11560	6850	8230	5000			6420	3930	8882
- 1.5m			12280*	12280*	16930*	10250	11410	6710	8140	4920			6940	4240	8378
- 3m	14130*	14130*	19190*	19190*	15890*	10370	11450	6750	8210	4980			8160	4950	7540
- 4.5m			18680*	18680*	13530	10690	9900*	7000					9350*	6670	6227





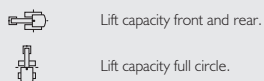









**LIFT CAPACITIES – Dipper length: 3.7m, Boom: 6.2m, Tracks: 900mm. JS300 LC MONO**

Load Point	Reach from Swing Centre														
	1.5m		3m		4.5m		6m		7.5m		9m		Max Reach		
															
Height	kg	kg	kg	kg	kg	kg	kg	kg	kg	kg	kg	kg	kg	kg	mm
7.5m									5780*	5780*			3960*	3960*	8089
6m									6270*	6000			3800*	3800*	8937
4.5m							7520*	7520*	6860*	5780	5860*	4200	3780*	3780*	9469
3m					11970*	11970*	9080*	7750	7690*	5480	6530	4060	3890*	3520	9738
1.5m					14850*	10930	10610*	7200	8450	5180	6360	3900	4140*	3410	9766
0m			6720*	6720*	16470*	10320	11540	6810	8190	4950	6220	3780	4550*	3450	9556
- 1.5m	7090*	7090*	10710*	10710*	16890*	10090	11300	6600	8040	4810	6170	3730	5250*	3680	9091
- 3m	11350*	11350*	15890*	15890*	16310*	10120	11270	6570	8030	4810			6480*	4190	8327
- 4.5m	16540*	16540*	20780*	20780*	14570*	10360	10810*	6730					8410*	5300	7165

















- Notes:**
1. Lifting capacities are based on ISO 10567, that is: 75% of minimum tipping load or 87% of hydraulic lift capacity, whichever is the less. Lifting capacities marked\* are based on hydraulic capacity.
  2. Lift capacities assume that the machine is on firm, level ground.
  3. Lift capacities may be limited by local regulations. Please refer to your dealer.















**LIFT CAPACITIES – Dipper length: 2.5m, Boom: 6.2m, Trackshoes: 600mm. JS300 NLC MONO**

Load Point	Reach from Swing Centre														
	1.5m		3m		4.5m		6m		7.5m		9m		Max Reach		
															
Height	kg	kg	kg	kg	kg	kg	kg	kg	kg	kg	kg	kg	kg	kg	mm
7.5m							7700*	7550					7810*	6470	6535
6m							8070*	7370	7770*	2050			7780*	4940	7565
4.5m					11580*	10790	9180*	6950	8120*	4870			7300	4180	8190
3m					14730*	9630	10590*	6460	8200	4640			6720	3800	8501
1.5m							11190	6050	7960	4420			6550	3650	8533
0m					17160*	8710	10910	5810	7790	4280			6740	3730	8291
- 1.5m			13200*	13200*	16620*	8720	10830	5750	7760	4250			7420	4080	7748
- 3m			20440*	17800	15140*	8910	10960	5850					9040	4940	6830
- 4.5m					11970*	9330							9890*	7300	5338

**LIFT CAPACITIES – Dipper length: 3.1m, Boom: 6.2m, Trackshoes: 600mm. JS300 NLC MONO**

Load Point	Reach from Swing Centre														
	1.5m		3m		4.5m		6m		7.5m		9m		Max Reach		
															
Height	kg	kg	kg	kg	kg	kg	kg	kg	kg	kg	kg	kg	kg	kg	mm
7.5m															
6m							7230*	7230*	7010*	5140				5190*	4330
4.5m					10220*	10220*	8390*	7110	7510*	4950				5230*	3730
3m					13410*	10010	9890*	6590	8270	4690	6100*	3460		5460*	3410
1.5m					15920*	9120	11280	6120	7980	4440	6020	3350		5900*	3280
0m					16990*	8710	10920	5810	7770	4250				6050	3330
- 1.5m					12280*	12280*	16930*	8620	10770	5680	4170			6550	3590
- 3m	14130*	14130*	19190*	17930	15890*	8730	10810	5720	7750	4230				7690	4200
- 4.5m			18680*	17970	13530*	9040	9900*	5970						9350*	5680

**LIFT CAPACITIES – Dipper length: 3.7m, Boom: 6.2m, Trackshoes: 600mm. JS300 NLC MONO**



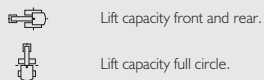











Load Point	Reach from Swing Centre														
	1.5m		3m		4.5m		6m		7.5m		9m		Max Reach		
															
Height	kg	kg	kg	kg	kg	kg	kg	kg	kg	kg	kg	kg	kg	kg	mm
7.5m										5780*	5300			3960*	3960*
6m										6270*	5230			3800*	3710
4.5m										6860*	5010			3780*	3250
3m					11970*	10340	9080*	6690	7690*	4720	6160	3460		3890*	2980
1.5m					14850*	8270	10610*	6160	7980	4420	5990	3310		4140*	2870
0m					6720*	6720*	16470*	8680	10900	5770	7720	4190	5860	3180	4550*
- 1.5m	7090*	7090*	10710*	10710*	16890*	8460	10660	5570	7570	4060	5800	3140		5250*	3090
- 3m	11350*	11350*	15890*	15890*	16310*	8490	10630	5540	7560	4050				6480*	3540
- 4.5m	16540*	16540*	20780*	17380	14570*	8720	10810	5690						8300	4500

















- Notes:**
- Lifting capacities are based on ISO 10567, that is: 75% of minimum tipping load or 87% of hydraulic lift capacity, whichever is the less. Lifting capacities marked\* are based on hydraulic capacity.
  - Lift capacities assume that the machine is on firm, level ground.
  - Lift capacities may be limited by local regulations. Please refer to your dealer.

















**LIFT CAPACITIES – Dipper length: 2.5m, Boom: 6.2m, Trackshoes: 700mm. JS300 NLC MONO**

Load Point	Reach from Swing Centre														
	1.5m		3m		4.5m		6m		7.5m		9m		Max Reach		
															
Height	kg	kg	kg	kg	kg	kg	kg	kg	kg	kg	kg	kg	kg	kg	mm
7.5m							7700*	7620					7810*	6540	6535
6m							8070*	7440	7770*	5070			7780*	4990	7565
4.5m					11580*	10900	9180*	7030	8120*	4930			7380	4230	8190
3m					14730*	9740	10590*	6530	8300	4700			6800	3840	8501
1.5m							11320	6120	8050	4480			6330	3700	8533
0m					17160*	8810	11040	5880	7890	4330			6830	3780	8291
- 1.5m			13200*	13200*	16620*	8830	10970	5820	7860	4310			7510	4130	7748
- 3m			20440*	17990	15140*	9010	11100	5930					9150	5000	6830
- 4.5m					11970*	9440							9890*	7390	5338

**LIFT CAPACITIES – Dipper length: 3.1m, Boom: 6.2m, Trackshoes: 700mm. JS300 NLC MONO**

Load Point	Reach from Swing Centre														
	1.5m		3m		4.5m		6m		7.5m		9m		Max Reach		
															
Height	kg	kg	kg	kg	kg	kg	kg	kg	kg	kg	kg	kg	kg	kg	mm
7.5m															
6m							7230*	7230*	7010*	5190			5190*	4380	8210
4.5m					10220*	10220*	8390*	7180	7510*	5000			5230*	3780	8787
3m					13410*	10110	9890*	6660	8270*	4740	6100*	3510	5460*	3450	9077
1.5m					15920*	9220	11280*	6190	8080	4490	6100	3390	5900*	3320	9108
0m					16990*	8820	11060	5880	7870	4300			6130	3370	8882
- 1.5m			12280*	12280*	16930*	8730	10900	5750	7770	4220			6640	3640	8378
- 3m	14130*	14130*	19190*	17580	15890*	8840	10940	5790	7850	4290			7790	4260	7540
- 4.5m			18680*	18170	13530*	9150	9900*	6040					9350*	5750	6227





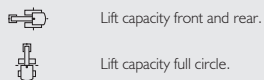









**LIFT CAPACITIES – Dipper length: 3.7m, Boom: 6.2m, Trackshoes: 700mm. JS300 NLC MONO**

Load Point	Reach from Swing Centre														
	1.5m		3m		4.5m		6m		7.5m		9m		Max Reach		
															
Height	kg	kg	kg	kg	kg	kg	kg	kg	kg	kg	kg	kg	kg	kg	mm
7.5m									5780*	5360			3960*	3960*	8089
6m									6270*	5280			3800*	3760	8937
4.5m							7520*	7320	6860*	5060	5860*	3640	3780*	3290	9469
3m					11970*	10440	9080*	6760	7690*	4770	6240	3500	3890*	3020	9738
1.5m					14850*	9380	10610*	6230	8080	4480	6070	3350	4140*	2910	9766
0m			6720*	6720*	16470*	8790	11030	5840	7820	4250	5930	3230	4550*	2940	9556
- 1.5m	7090*	7090*	10710*	10710*	16890*	8570	10800	5640	7670	4110	5880	3180	5250*	3140	9091
- 3m	11350*	11350*	15890*	15890*	16310*	8600	10760	5610	7660	4110			6480*	3580	8327
- 4.5m	16540*	16540*	20780*	17580	14570*	8830	10810*	5770					8400	4560	7165

















- Notes:**
1. Lifting capacities are based on ISO 10567, that is: 75% of minimum tipping load or 87% of hydraulic lift capacity, whichever is the less. Lifting capacities marked\* are based on hydraulic capacity.
  2. Lift capacities assume that the machine is on firm, level ground.
  3. Lift capacities may be limited by local regulations. Please refer to your dealer.















**LIFT CAPACITIES – Dipper length: 2.5m, Boom: 6.2m, Trackshoes: 800mm. JS300 NLC MONO**

Load Point	Reach from Swing Centre														
	1.5m		3m		4.5m		6m		7.5m		9m		Max Reach		
															
Height	kg	kg	kg	kg	kg	kg	kg	kg	kg	kg	kg	kg	kg	kg	mm
7.5m							7700*	7700*					7810*	6680	6535
6m							8070*	7600	7770*	5200			7780*	5110	7565
4.5m					11580*	11130	9180*	7190	8120*	5050			7580	4340	8190
3m					14730*	9980	10590*	6690	8520	4820			6990	3950	8501
1.5m							11620	6280	8270	4600			6810	3810	8533
0m					17160*	9050	11340	6040	8110	4460			7020	3890	8291
- 1.5m			13200*	13200*	16620*	9070	11270	5980	8080	4430			7720	4250	7748
- 3m			20440*	18440	15140*	9250	11400	6090					9400	5140	6830
- 4.5m					11970*	9680							9890*	7570	5338

**LIFT CAPACITIES – Dipper length: 3.1m, Boom: 6.2m, Trackshoes: 800mm. JS300 NLC MONO**

Load Point	Reach from Swing Centre														
	1.5m		3m		4.5m		6m		7.5m		9m		Max Reach		
															
Height	kg	kg	kg	kg	kg	kg	kg	kg	kg	kg	kg	kg	kg	kg	mm
7.5m															
6m							7230*	7230*	7010*	5320				5190*	4490
4.5m					10220*	10220*	8390*	7340	7510*	5130				5230*	3880
3m					13410*	10350	9890*	6820	8270*	4870	6100*	3610		5460*	3550
1.5m					15920*	9460	11280*	6350	8300	4610	6270	3490		5900*	3420
0m					16990*	9060	11360	6040	8090	4430				6300	3470
- 1.5m			12280*	12280*	16930*	8970	11200	5910	7990	4340				6820	3740
- 3m	14130*	14130*	19190*	18030	15890*	9070	11250	5950	8070	4410				8010	4380
- 4.5m			18680*	18610	13530*	9390	9900*	6200						9350*	6227





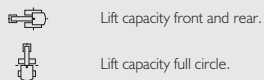









**LIFT CAPACITIES – Dipper length: 3.7m, Boom: 6.2m, Trackshoes: 800mm. JS300 NLC MONO**

Load Point	Reach from Swing Centre														
	1.5m		3m		4.5m		6m		7.5m		9m		Max Reach		
															
Height	kg	kg	kg	kg	kg	kg	kg	kg	kg	kg	kg	kg	kg	kg	mm
7.5m									5780*	5480				3960*	3960*
6m									6270*	5400				3800*	3800*
4.5m							7520*	7490	6860*	5180	5860*	3740		3780*	3380
3m					11970*	10680	9080*	6930	7690*	4890	6410	3600		3890*	3110
1.5m					14850*	9620	10610*	6390	8300	4600	6240	3450		4140*	3000
0m			6720*	6720*	16470*	9020	11340	6010	8040	4370	6110	3330		4550*	3040
- 1.5m	7090*	7090*	10710*	10710*	16890*	8810	11100	5810	7890	4240	6050	3280		5250*	3230
- 3m	11350*	11350*	15890*	15890*	16310*	8830	11060	5780	7880	4230				6480*	3690
- 4.5m	16540*	16540*	20780*	18030	14570*	9070	10810*	5930						8410*	4690

















- Notes:**
- Lifting capacities are based on ISO 10567, that is: 75% of minimum tipping load or 87% of hydraulic lift capacity, whichever is the less. Lifting capacities marked\* are based on hydraulic capacity.
  - Lift capacities assume that the machine is on firm, level ground.
  - Lift capacities may be limited by local regulations. Please refer to your dealer.















**LIFT CAPACITIES – Dipper length: 2.5m, Boom: 6.2m, Trackshoes: 900mm. JS300 NLC MONO**

Load Point	Reach from Swing Centre														
	1.5m		3m		4.5m		6m		7.5m		9m		Max Reach		
															
Height	kg	kg	kg	kg	kg	kg	kg	kg	kg	kg	kg	kg	kg	kg	mm
7.5m							7700*	7700*					7810*	6760	6535
6m							8070*	7690	7770*	5260			7780*	5180	7565
4.5m					11580*	11260	9180*	7270	8120*	5120			7680	4400	8190
3m					14730*	10100	10590*	6780	8630	4880			7080	4010	8501
1.5m							11780	6360	8390	4660			6910	3860	8533
0m					17160*	9180	11500	6130	8220	4520			7120	3940	8291
- 1.5m			13200*	13200*	16620*	9190	11430	6060	8190	4490			7830	4310	7748
- 3m			20440*	18680	15140*	9380	11430*	6170					9530	5210	6830
- 4.5m					11970*	9800							9890*	7670	5338

**LIFT CAPACITIES – Dipper length: 3.1m, Boom: 6.2m, Trackshoes: 900mm. JS300 NLC MONO**

Load Point	Reach from Swing Centre														
	1.5m		3m		4.5m		6m		7.5m		9m		Max Reach		
															
Height	kg	kg	kg	kg	kg	kg	kg	kg	kg	kg	kg	kg	kg	kg	mm
7.5m															
6m							7230*	7230*	7010*	5380			5190*	4550	8210
4.5m					10220*	10220*	8390*	7430	7510*	5190			5230*	3930	8787
3m					13410*	10480	9890*	6910	8270*	4930	6100*	3660	5460*	3600	9077
1.5m					15920*	9580	11280*	6440	8410	4680	6360	3540	5900*	3470	9108
0m					16990*	9180	11510	6130	8200	4490			6390	3530	8882
- 1.5m			12280*	12280*	16930*	9090	11360	6000	8110	4410			6920	3800	8378
- 3m	14130*	14130*	19190*	18720	15890*	9200	11400	6030	8180	4470			8120	4440	7540
- 4.5m			18680*	18680*	13530*	9510	9900*	6280					9350*	5990	6227

**LIFT CAPACITIES – Dipper length: 3.7m, Boom: 6.2m, Trackshoes: 900mm. JS300 NLC MONO**



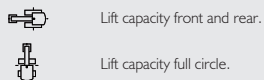







Load Point	Reach from Swing Centre														
	1.5m		3m		4.5m		6m		7.5m		9m		Max Reach		
															
Height	kg	kg	kg	kg	kg	kg	kg	kg	kg	kg	kg	kg	kg	kg	mm
7.5m									5780*	5540			3960*	3960*	8089
6m									6270*	5470			3800*	3800*	8937
4.5m							7520*	7520*	6860*	5250	5860*	3790	3780*	3430	9469
3m					11970*	10810	9080*	7010	7690*	4960	6500	3660	3980*	3160	9738
1.5m					14850*	9740	10610*	6480	8410	4660	6330	3500	4140*	3050	9766
0m			6720*	6720*	16470*	9150	11490	6090	8150	4430	6200	3380	4550*	3080	9556
- 1.5m	7090*	7090*	10710*	10710*	16890*	8930	11260	5890	8000	4300	6140	3330	5250*	3290	9091
- 3m	11350*	11350*	15890*	15890*	16310*	8960	11220	5860	7990	4290			6480*	3750	8327
- 4.5m	16540*	16540*	20780*	18260	14570*	9190	10810*	6010					8410*	4750	7165

















- Notes:**
1. Lifting capacities are based on ISO 10567, that is: 75% of minimum tipping load or 87% of hydraulic lift capacity, whichever is the less. Lifting capacities marked\* are based on hydraulic capacity.
  2. Lift capacities assume that the machine is on firm, level ground.
  3. Lift capacities may be limited by local regulations. Please refer to your dealer.

















**LIFT CAPACITIES – Dipper length: 2.5m, Boom: 6.2m, Tracks: 600mm. JS300 LC MONO (HEAVY COUNTERWEIGHT)**

Load Point	Reach from Swing Centre														
	1.5m		3m		4.5m		6m		7.5m		9m		Max Reach		
															
Height	kg	kg	kg	kg	kg	kg	kg	kg	kg	kg	kg	kg	kg	kg	mm
7.5m							7700*	7700*					7810*	7600	6535
6m							8070*	8070*	7770*	5950			7780*	5850	7565
4.5m					11580*	11580*	9180*	8230	8120*	5800			7810	5000	8190
3m					14730*	11610	10590*	7720	8770*	5560			7200	4580	8501
1.5m							11800*	7377	8530	5340			7030	4430	8533
0m					17160*	10660	11700	7060	8370	5190			7240	4530	8291
- 1.5m			13200*	13200*	16620*	10670	11620	6990	8340	5170			7970	4960	7748
- 3m			20440*	20440*	15140*	10860	11430*	7100					9690	5980	6830
- 4.5m					11970*	11300							9890*	8800	5338

**LIFT CAPACITIES – Dipper length: 3.1m, Boom: 6.2m, Tracks: 600mm. JS300 LC MONO (HEAVY COUNTERWEIGHT)**







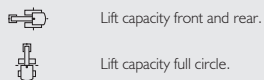







Load Point	Reach from Swing Centre														
	1.5m		3m		4.5m		6m		7.5m		9m		Max Reach		
															
Height	kg	kg	kg	kg	kg	kg	kg	kg	kg	kg	kg	kg	kg	kg	mm
7.5m													5370*	5370*	7275
6m							7230*	7230*	7010*	6070			5190*	5150	8210
4.5m					10220*	10220*	8390*	8390	7510*	5880			5230*	4480	8787
3m					13410*	12000	9890*	7850	8270*	5610	6100*	4190	5460*	4130	9077
1.5m					15920*	11080	11280*	7370	8550	5350	6470	4070	5900*	3990	9108
0m					16990*	10660	11710	7060	8340	5160			6510	4160	8882
- 1.5m			12280*	12280*	16930*	10570	11560	6930	8250	5080			7050	4380	8370
- 3m	14130*	14130*	19190*	19190*	15890*	10680	11600	6960	8320	5150			8260	5110	7540
- 4.5m			18680*	18680*	13530*	11010	9900*	7220					9350*	6870	6220















**LIFT CAPACITIES – Dipper length: 3.7m, Boom: 6.2m, Tracks: 600mm. JS300 LC MONO (HEAVY COUNTERWEIGHT)**















Load Point	Reach from Swing Centre														
	1.5m		3m		4.5m		6m		7.5m		9m		Max Reach		
															
Height	kg	kg	kg	kg	kg	kg	kg	kg	kg	kg	kg	kg	kg	kg	mm
7.5m									5780*	5780*			3960*	3960*	8089
6m									6270*	6160			3800*	3800*	8937
4.5m							7520*	7520*	6860*	5940	5860*	4330	3780*	3780*	9469
3m					11970*	11970*	9080*	7960	7690*	5640	6610	4190	3890*	3640	9738
1.5m					14850*	11250	10610*	7420	8560	5340	6440	4030	4140*	3530	9766
0m			6720*	6720*	16470*	10630	11690	7020	8290	5110	6310	3910	4550*	3570	9556
- 1.5m	7090*	7090*	10710*	10710*	16890*	10410	11450	6820	8140	4970	6180*	3860	5250*	3810	9091
- 3m	11350*	11350*	15890*	15890*	16310*	10440	11420	6790	8140	4970			6480*	4330	8327
- 4.5m	16540*	16540*	20780*	20780*	14570*	10680	10810*	6940					8410	5470	7165



- Notes:**
- Lifting capacities are based on ISO 10567, that is: 75% of minimum tipping load or 87% of hydraulic lift capacity, whichever is the less. Lifting capacities marked\* are based on hydraulic capacity.
  - Lift capacities assume that the machine is on firm, level ground.
  - Lift capacities may be limited by local regulations. Please refer to your dealer.

LIFT CAPACITIES – Dipper length: 2.5m, Boom: 6.2m, Trackshoes: 800mm.														JS300 NLC MONO (HEAVY COUNTERWEIGHT)		
Load Point	Reach from Swing Centre															
	1.5m		3m		4.5m		6m		7.5m		9m		Max Reach			
																
Height	kg	kg	kg	kg	kg	kg	kg	kg	kg	kg	kg	kg	kg	kg	mm	
7.5m							7700*	7700*						7810*	6960	6535
6m							8070*	7910	7770*	5430				7780*	5340	7565
4.5m					11580*	11580	9180*	7490	8120*	5280				7770*	4550	8190
3m					14730*	10420	10590*	7000	8740	5050				7170	4150	8501
1.5m							11800*	6590	8490	4830				7000	4000	8533
0m					17160*	9500	11650	6350	8330	4690				7210	4090	8291
- 1.5m			13200*	13200*	16620*	9520	11570	6290	8300	4660				7930	4470	7748
- 3m			20440*	19290	15140*	9700	11430*	6400						9650	5400	6830
- 4.5m					11970*	10120								9980*	7930	5338

LIFT CAPACITIES – Dipper length: 3.1m, Boom: 6.2m, Trackshoes: 800mm.														JS300 NLC MONO (HEAVY COUNTERWEIGHT)		
Load Point	Reach from Swing Centre															
	1.5m		3m		4.5m		6m		7.5m		9m		Max Reach			
																
Height	kg	kg	kg	kg	kg	kg	kg	kg	kg	kg	kg	kg	kg	kg	mm	
7.5m														5370*	5370*	7275
6m							7230*	7230*	7010*	5550				5190*	4700	8210
4.5m							8390*	7650	7510*	5360				5230*	4070	8787
3m					13410*	10800	9890*	7130	8270*	5100	6100*	3790		5460*	3740	9077
1.5m					15920*	9910	11280*	6660	8520	4840	6440	3680		5900*	3610	9108
0m					16990*	9510	11660	6350	8310	4660				6480	3660	8882
- 1.5m			12280*	12280*	16930*	9420	11510	6220	8210	4580				7020	3950	8378
- 3m			19190*	18880	15890*	9520	11550	6260	8290	4640				8240	4610	7540
- 4.5m			18680*	18680*	13530*	9840	9900*	6510						9350*	6200	6227

LIFT CAPACITIES – Dipper length: 3.7m, Boom: 6.2m, Trackshoes: 800mm.														JS300 NLC MONO (HEAVY COUNTERWEIGHT)		
Load Point	Reach from Swing Centre															
	1.5m		3m		4.5m		6m		7.5m		9m		Max Reach			
																
Height	kg	kg	kg	kg	kg	kg	kg	kg	kg	kg	kg	kg	kg	kg	mm	
7.5m										5780*	5710			3960*	3960*	8089
6m										6270	5640			3800*	3800*	8937
4.5m										7520*	7520*	6860*	5420	5860*	3930	9469
3m										9080*	7230	7690*	5130	6580	3790	9738
1.5m										10610*	6700	8520	4830	6420	3640	9766
0m										11640	6310	8260	4600	6280	3510	9556
- 1.5m	7090*	7090*	10710*	10710*	16890*	9260	11400	6110	8110	4470	6180*	3470		5250*	3420	9091
- 3m	11350*	11350*	15890*	15890*	16310*	9280	11370	6080	8100	4460				6480*	3900	8327
- 4.5m	16540*	16540*	20780*	18870	14570*	9510	10810*	6240						8410*	4930	7165

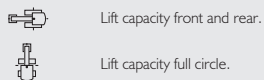

**Notes:**

- Lifting capacities are based on ISO 10567, that is: 75% of minimum tipping load or 87% of hydraulic lift capacity, whichever is the less. Lifting capacities marked\* are based on hydraulic capacity.
- Lift capacities assume that the machine is on firm, level ground.
- Lift capacities may be limited by local regulations. Please refer to your dealer.



**ONE COMPANY, OVER 300 MACHINES.**

Your nearest JCB dealer

**Tracked Excavator JS300 LC/NLC**

Net engine power: 180 kW (241 hp) Bucket capacity: 0.86 – 1.93 m<sup>3</sup>  
 Operating weight: 31140 – 33487 kg

JCB Sales Limited, Rokester, Staffordshire, United Kingdom ST14 5JP.  
 Tel: +44 (0)1889 590312 Email: salesinfo@jcb.com  
 Download the very latest information on this product range at: [www.jcb.com](http://www.jcb.com)

©2017 JCB Sales. All rights reserved. No part of this publication may be reproduced, stored in a retrieval system, or transmitted in any form or by any other means, electronic, mechanical, photocopying or otherwise, without prior permission from JCB Sales. All references in this publication to operating weights, sizes, capacities and other performance measurements are provided for guidance only and may vary dependant upon the exact specification of machine. They should not therefore be relied upon in relation to suitability for a particular application. Guidance and advice should always be sought from your JCB Dealer. JCB reserves the right to change specifications without notice. Illustrations and specifications shown may include optional equipment and accessories. All images are correct at time of print. The JCB logo is a registered trademark of J C Bamford Excavators Ltd.



9999/5993 en-GB 11/16 Issue 1 (T4F)

